

**LEGENDA**

**DT** dotok  
**IZ** iztok

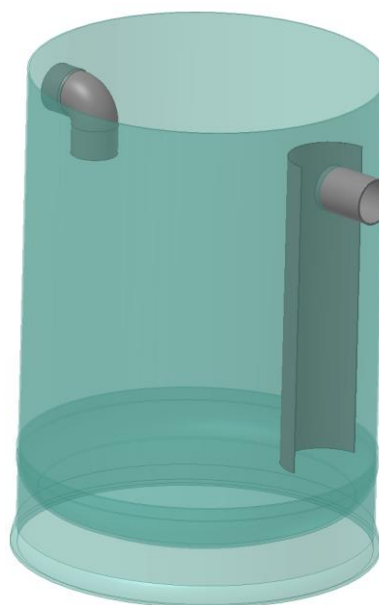
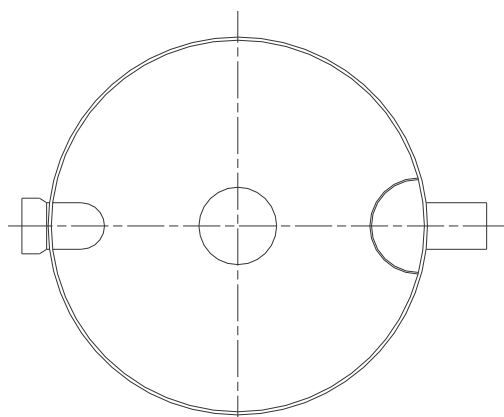

**GRAVITACIJSKI LOVILEC OLJ NV8**

**TEHNIČNI PODATKI**

Pretok skozi lovilca olj:	8 lit/s
Prostornina lovilca olj:	1,43 m <sup>3</sup>
Teža posode z vgrajeno opremo:	80 kg



**AMT projekt**

AMT projekt d.o.o  
Petrina 11 SI- 1336 KOSTEL

Tel.: 08 200 75 57, e-mail: [info@amtprojekt.si](mailto:info@amtprojekt.si)